

# An important message about floor mats. From Lexus.

La présente lettre a été envoyée en fonction de la préférence de langue indiquée dans nos dossiers, par numéro d'identification du véhicule (NIV). Si vous désirez consulter cette lettre en anglais/français, veuillez visiter notre site Web: [www.lexus.ca/secureite](http://www.lexus.ca/secureite).

This letter has been sent based on the language preference on file, by Vehicle Identification Number (VIN). If you wish to view this letter in English/French, please visit our website: [www.lexus.ca/safety](http://www.lexus.ca/safety).

DEAR LEXUS GUEST,

Lexus is committed to manufacturing vehicles and products that exceed your expectations for quality, reliability and safety. This is why we want to take this opportunity to share some important information with you concerning the selection and installation of floor mats in your vehicle. This is not a recall letter; it is simply our way of sharing information that relates to your continued satisfaction with Lexus products.

## THE FACTS

Every Lexus vehicle sold in Canada is equipped with a set of original equipment carpet floor mats or all-weather floor mats. Guests who purchase a vehicle with carpet mats may also choose to purchase optional genuine accessory Lexus all-weather floor mats for their vehicle.

Lexus floor mats are only available at Lexus dealerships and are designed to match the size of space on the floor in the specific Lexus model in which they are intended to be used. In addition, the driver's side floor mat has a cut-out area for the vehicle's accelerator and brake pedals to help avoid interference with the movement of the pedals during driving. Lexus floor mats have a non-skid backing that helps to protect the vehicle's carpet from moisture and Lexus vehicles have retaining clips or hooks to secure the floor mat and help prevent the floor mat from moving forward and interfering with the pedals. When the correct floor mat is properly installed and secured using the retaining clips or hooks provided with the vehicle, there is no risk of pedal entrapment.



NOVEMBER 2010

## USING FLOOR MATS

You should ensure that you are using a floor mat that matches the size of the space on the carpet in your vehicle. The floor mat should be properly installed and secured. Please do not flip the mat over such that the bottom side is up, and you should **never** stack one floor mat on top of another. Should you choose to install all-weather floor mats in your vehicle, Lexus recommends only using genuine Lexus accessory all-weather floor mats that have been designed specifically for your model. Only **one** floor mat, either the original equipment floor mat or the genuine Lexus accessory all-weather floor mat, should be installed in the driver's position.

Your confidence in the quality and safety of our products is important to Lexus. Accordingly, we are including with this letter the following information to help keep you safe and to provide you with a better understanding of your vehicle:

- How to properly install floor mats in your vehicle.
- Normal vehicle operating conditions.

If you have additional questions about the floor mats in your vehicle, please contact your local Lexus dealer. You may also visit [Lexus.ca](http://Lexus.ca) for information about Lexus Floor Mats or Transport Canada's website on Vehicle Floor Mat Interference with Accelerator (Gas) and Brake Pedals [www.tc.gc.ca](http://www.tc.gc.ca).

We hope you find this information valuable, and would like to take this opportunity to thank you for driving a Lexus.

LEXUS CANADA

# Lexus Carpeted / All-Weather Floor Mat Inspection, Application and Installation Instructions

---

## Read these important warnings BEFORE installing ANY type of floor mat

Only install floor mats designed specifically for the model and model year of your vehicle. Check for correct part description and part number information on the packaging label to confirm.

- Never install a floor mat if it was not designed for use in your vehicle.
- Never install a floor mat upside down or turned over for any reason.
- Only install the driver's side floor mat designed specifically for your vehicle's model and model year in the driver's foot area.

Always properly secure the driver's side floor mat using the retaining hooks (clips) supplied in the bag with the original floor mats. Follow the floor mat retention clip installation instruction supplied with the clips. If the floor mat designed specifically for your vehicle's model and model year is properly secured, it will not interfere with the accelerator pedal.

- Never install the front driver's side floor mat without all retaining hooks (clips) securing the mat firmly in place.

The retaining hooks (clips) are designed to accommodate only one floor mat at a time.

- Do not install another floor mat(s) on top of an existing driver's side floor mat.

After installation, always check the operation of the accelerator, brake and clutch (if applicable) pedals to ensure the floor mat does not interfere with them.

Carefully read the warning tag attached to the driver's side floor mat regarding installation.

Regularly verify the correct floor mat is securely installed in your vehicle using the retaining hooks (clips).

---

## CHECK REGULARLY FOR CORRECT FLOOR MAT INSTALLATION

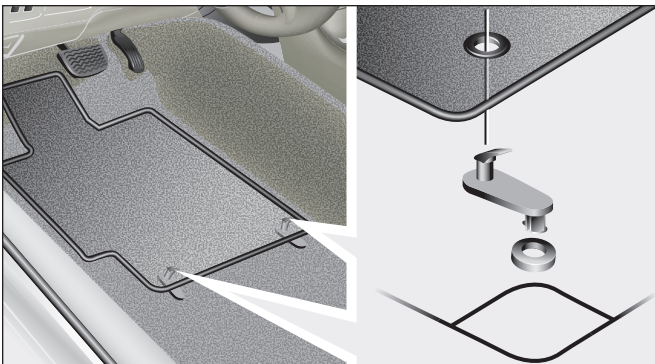

Ensure the retaining hooks (clips) are properly installed and secured into the eyelet(s) located in the driver's side foot well.

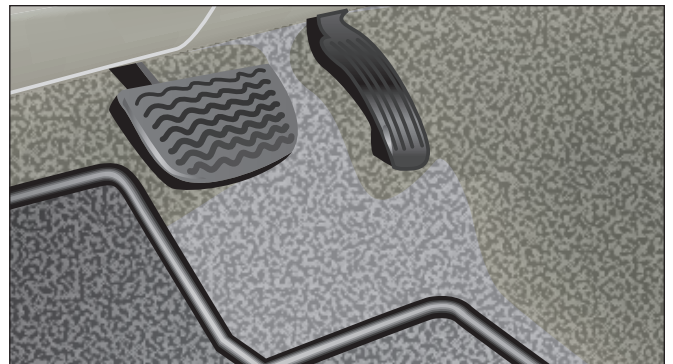







Check the pedal operation by fully depressing the pedal to ensure the floor mat does not interfere with it. When testing, make sure the vehicle is off, in 'Park' (for automatic transmission models) and the parking brake is on.

## Understanding Normal Vehicle Operation

There may be a number of operation conditions where you may experience a slight change in engine speed. These conditions do not indicate a problem, in fact, they are normal. We are providing you with this information to ensure that you have accurate information regarding your vehicle.

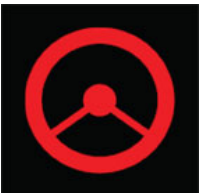
Note: Some of the features listed below are optional on some vehicles and may not be applicable to your specific vehicle.

	<p><b>Air Conditioner Idle-Up</b></p> <p>An engine-driven air conditioner compressor may exhibit a slight increase in engine RPM when the air conditioner compressor cycles on. This increase in engine idle speed reflects normal compensation for the increase load of the air conditioner compressor.</p>
	<p><b>Catalyst Protection</b></p> <p>On certain vehicles equipped with manual transmissions, the engine computer may momentarily keep the engine speed above idle when shifting out of fifth or sixth gear at highway speeds. This condition occurs only briefly and only when the vehicle is in neutral. It is designed to prolong the life of the catalytic converter.</p>
	<p><b>Cold Idle-Up</b></p> <p>The engine control module is programmed to raise engine idle speed slightly following a cold start. This higher engine idle speed is a normal function of a cold engine. The idle speed decreases once the engine begins to warm up.</p>
	<p><b>Conventional Cruise Control</b></p> <p>When conventional cruise control is engaged and the set speed is above the vehicle speed, it is normal for the vehicle to accelerate to the set speed. Cruise control does not have the ability to slow the vehicle if the driver accelerates the vehicle above the set speed, or if the vehicle gains speed while descending a hill.</p>
	<p><b>Dynamic Radar Cruise Control</b></p> <p>When Dynamic Radar Cruise Control is engaged and the desired speed is above the vehicle speed, it is normal for the vehicle to accelerate to the desired speed when the lane in front of the vehicle is clear. Dynamic Radar Cruise Control does not have the ability to slow the vehicle if the driver accelerates the vehicle above the set speed or if the vehicles gains speed while descending a hill.</p>
	<p><b>Power Steering Idle-Up</b></p> <p>Vehicles equipped with hydraulic power steering may exhibit a slight increase in engine RPM when turning the steering wheel at lower vehicle speeds. This increase in engine RPM reflects a normal response to the increase load of the power steering system.</p>
	<p><b>Transmission Shift</b></p> <p>When accelerating at low to moderate vehicle speeds, the automatic transmission may downshift to a lower gear. When this downshift occurs, it is normal for the engine speed to increase, enhancing vehicle acceleration.</p>